



eCLIQ System: The key to electronic locking

ASSA ABLOY

Technical Overview

The global leader in
door opening solutions

eCLIQ: The key to electronic locking

More durable, more secure and more efficient than conventional locking systems

A completely electronic locking system, eCLIQ is based on the mechanical precision and microelectronic modules of ASSA ABLOY's CLIQ® technology.

Secure, reliable and uncomplicated, the powerful microelectronics in the programmable waterproof key and compact electronic locking cylinder together provide the strongest possible security.

eCLIQ solves the problem of lost keys. As each key is individually programmable, access rights can easily be deleted leading to higher security.



Cylinders are easy and quick to install, no cabling is needed.

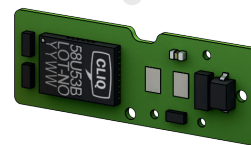
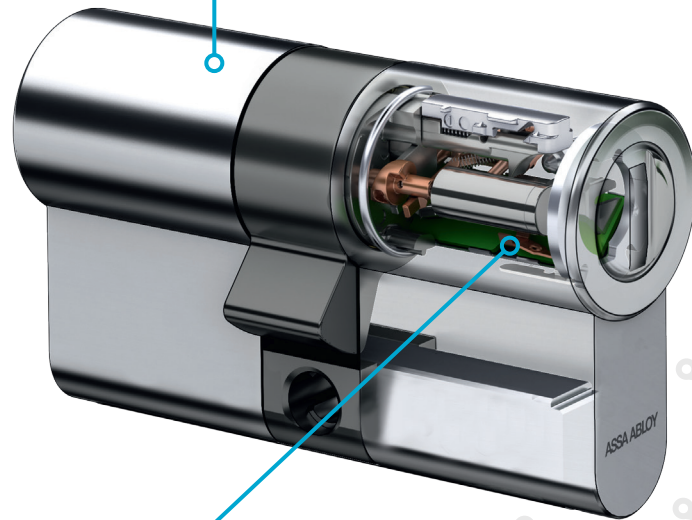

New, future-proof CLIQ® chip generation with AES encryption and rapid processing speed with efficient energy management.



Compact, programmable, reversible, waterproof key with LED function display and acoustic.



The electronic contact between keys and cylinders transmits power and data securely.

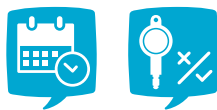

Keys and cylinders can be programmed with flexible access rights and schedules.



Fast, easy standard battery replacement in the key – no need for tools.

Managing the eCLIQ system

Maximum flexibility to assign and revoke access rights

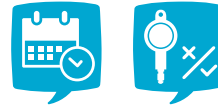
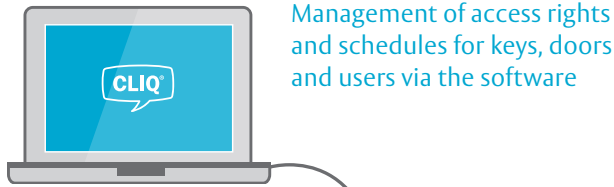

The programmer transfers access rights and receives audit trails from keys

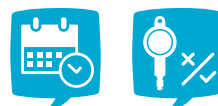
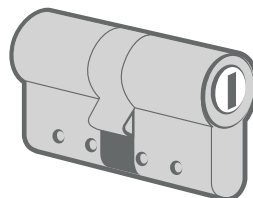
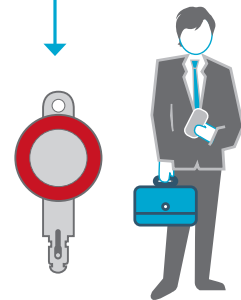
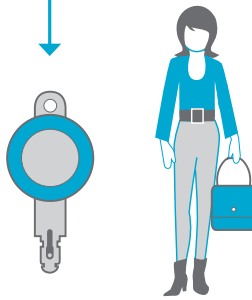

eCLIQ fits everywhere

Easy installation – no wiring required

The compact eCLIQ locking cylinder offers the highest levels of security. With the widest range of different cylinder types, the system is designed for every kind of use from the company entrance gate to securing the alarm systems, lifts, doors and cabinets.

The system offers certifications for all areas of use, including external areas, ensuring building operators comply with current and future regulations.

eCLIQ – total design flexibility

- Modular system
- Wide range of locking cylinders
- 200,000 cycles of maintenance-free use
- Easy installation, no wiring



Alarm systems
e.g. Half-cylinder



Outdoor containers
e.g. Padlock

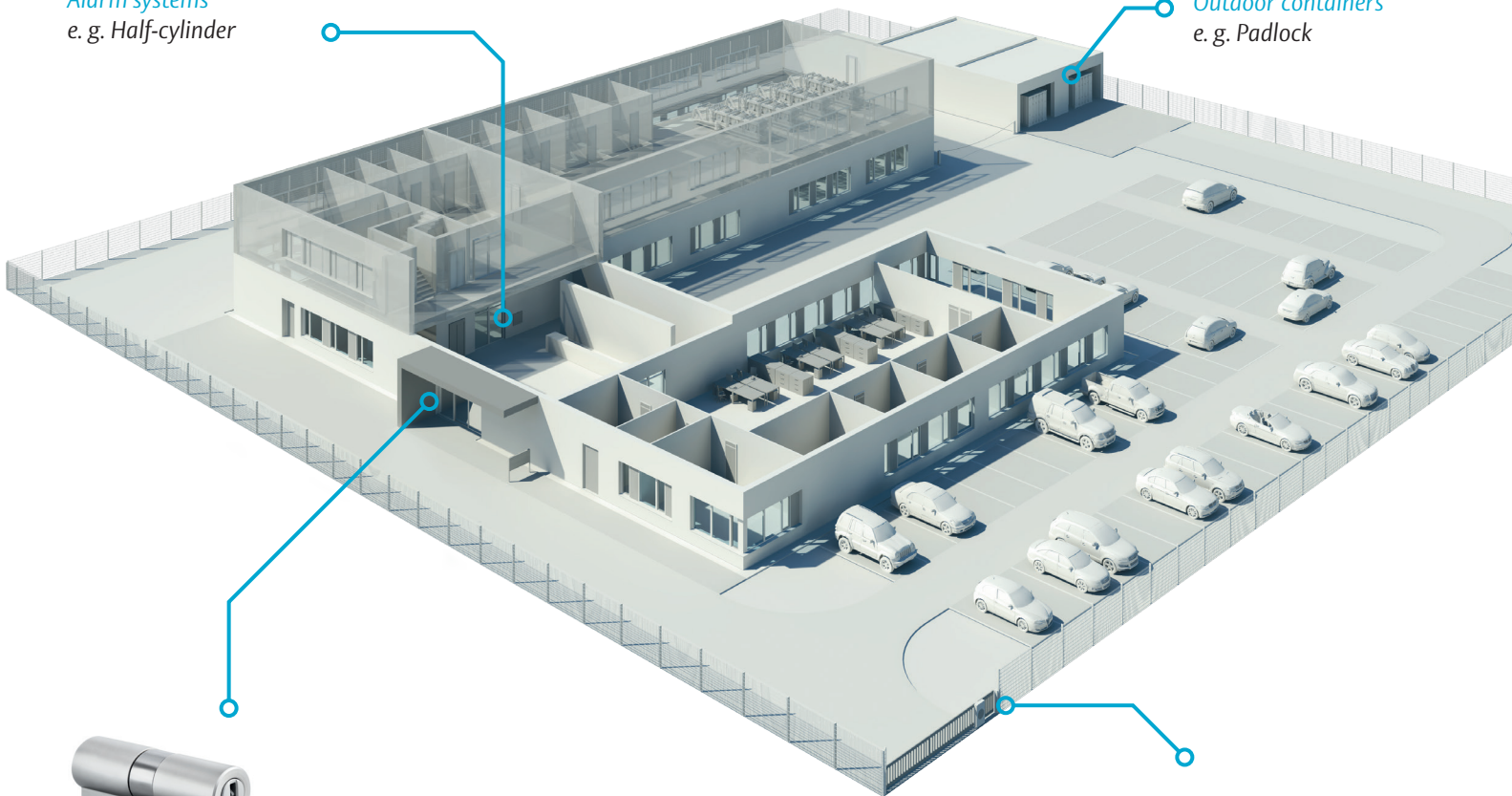

Main Entrance
e.g. Double cylinder

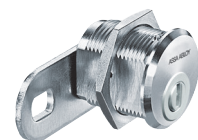

Mail box systems
e.g. Locking lever cylinder

The eCLIQ locking system in action

Designed to deliver maximum flexibility and enhanced security for any organisation

Staff changes, short-term employment contracts and partnerships with external companies, are all part of day-to-day operations. Lost keys can easily find their way into unauthorised hands.

The eCLIQ locking system overcomes the challenge of constantly changing access rights. For maximum flexibility and convenience combined with the highest security, eCLIQ is the logical solution.

Examples

Administration on the go



The administrator can manage the system via the CLIQ® Web Manager, anytime, anywhere – the only requirement is Internet access.

Administration on site



The receptionist programmes and supervises the issuance/return of the visitor key with the CLIQ® Web Manager.

Employee on site

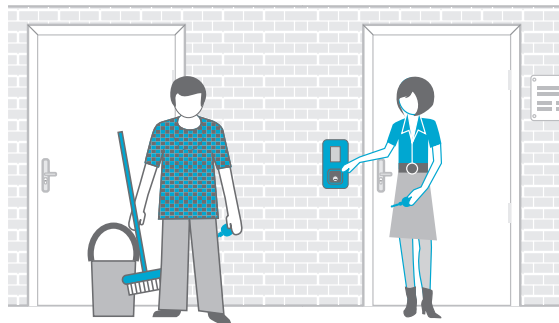

For doors with a lower security level, users such as cleaners can have access with no time limitation.

For doors with a high security level such as the entrance, access rights for the user keys are updated daily from the wall programmer. If a key is lost, access is denied after 24 hours ensuring higher security.

More durable, more secure and more efficient than conventional locking systems, eCLIQ provides enhanced protection for all sizes and types of property delivering the greatest flexibility in the issuance of access rights.

Employee on the go



An employee loses her key and informs the administrator. The administrator revokes the access rights of the key in the software and updates the cylinders, quickly solving the problem.

Employees or contractors on site or out in the field



Security staff use CLIQ® Web Manager and the programming key at a different location to modify authorisations for the locking cylinder or read out audit trails.

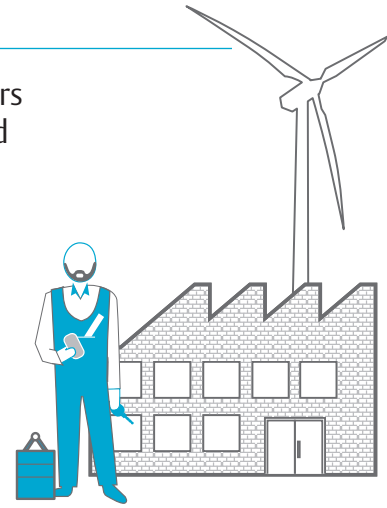

For remote locations, users can receive time-limited access rights with their keys using the CLIQ Connect key and mobile phone.

eCLIQ system components

Keys

- Compact key design ensures stability for problem-free, long-lasting operation
- Reversible key: Always fits, regardless of which direction it faces when inserted in the cylinder
- Optical and acoustic signaling for access entitlements, time zones and battery status
- Protected against temporary immersion in water (IP67)
- Integrated standard battery (CR2032 lithium cell) for approximately 30,000 cycles (service life of approx. 3 years). Battery replacement in the key does not require tools.

Programming key

The red programming key is used to transmit changes in authorisation and event logs between the software and locking cylinders. The key also authorises the use of the software.



User key

remote
with time-restricted access rights and event logs plus temporary issuance of access rights

connect
all the functionality of the remote key with the ability to update and validate via the CLIQ CONNECT Smart Phone App

User key "Beluga"

Designed for use in outdoor installation (-30°C to +50°C), for example, storage in the fire service safe.



User key "Ex"

User keys are optionally available for use in potentially-explosive areas in Zone 1 (II 2G Ex ib IIB T4)

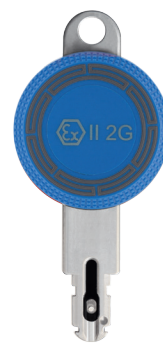

eCLIQ system components

Cylinders

- High-security protection against manipulation and intelligent break-in attempts
- Integrated microchip for storage of locking authorisations and event logs
- Use in environments with demanding ambient conditions (Temperature range: -25°C to +85°C)
- Maintenance-free up to 200,000 cycles (includes integrated lubricant reserve)
- Central key channel and low core overlap for problem-free installation in combination with security fittings and other locks
- Optional enhanced drilling protection
- Emergency mechanism with user key

Cylinder

The cylinders automatically register all programmed access entitlements and locking processes.



Authorisations

1,000 memory cells for individual keys and groups (each containing over 65,000 keys)

Locking functions

up to 1,500 keys

Event memory

up to 750 events

Optional dust and rain protection cap

Outdoor cylinders designed for all weather conditions, e.g. on radio masts. The cap ensures IP55 and fits all cylinder types.



eCLIQ also available with transponder

Key with integrated RFID chip for integration into control of transponder-based systems, e.g. access control systems.

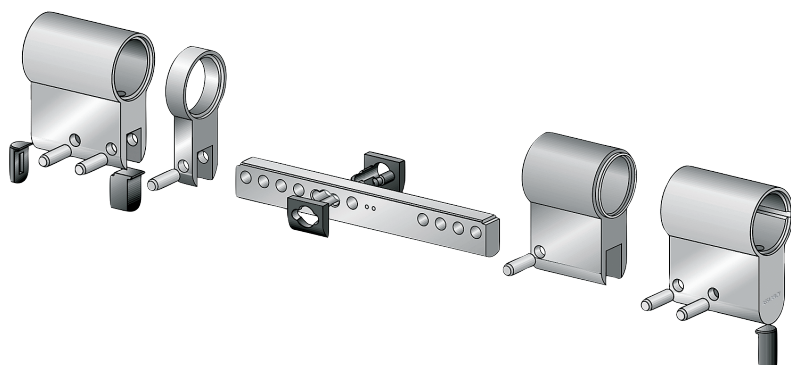

Flexible modular system

Euro Profile cylinders in lengths starting from 28 mm per side. Standard lengths of 60 mm can be extended in 5 mm increments up to a total length of 120 mm. Special lengths are also available in 10 mm increments up to a total length of 240 mm.

eCLIQ system components

Management software

eCLIQ system offers two management software versions for programming and management of access rights and schedules for keys, doors and users.

CLIQ® Web Manager



Web Application
System Management
from any location

- Internet application for multiple administrators, used on the client through a standard web browser accessed by the client
- Ideal for managing very large locking systems as well as locking systems spread out over multiple locations
- Enhanced search functions, intelligent assignment and filter functions
- Improved design and “step-by-step” user guidance (requires less training)
- Simple installation and administration through platform-independent design
- Central server and data storage completely network-compatible client/server design – ASSA ABLOY offers Software as a Service Hosting
- Web service interface (.Xml) for communication with third-party applications
- Network connections, 128-bit SSL encryption plus the security afforded by software certificates on client and server



CLIQ® Connect

- Smart Phone App available for both Android and iOS devices.
- Update keys anywhere anytime with integrated Bluetooth Low Energy technology.
- Online opening function for immediate notification of openings.
- PIN Validation feature for offline updates of keys.
- Easy pairing with Smart Phone
- Secure AES encrypted data transfer via Bluetooth protocol.

CLIQ CONNECT

Key Management from
any location

eCLIQ system components

Programmer

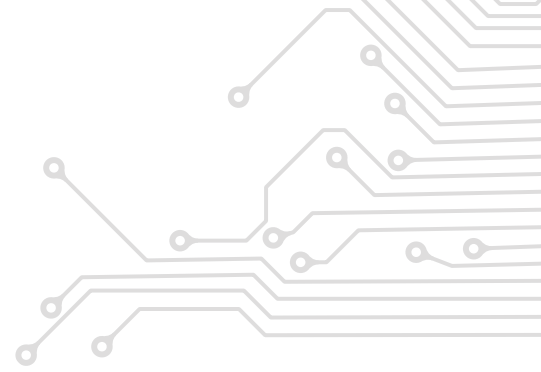

The programmer permits changes to times and authorisations (depending on key type) as well the read-out of audit trails.



Desktop Programmer
Used locally and centrally

Desktop programmer

- Communication interface for secure data transmission between CLIQ® Manager and programming key
- Programming of user keys and reading station for the audit trail memory in the user key .

- Access rights in the software (e.g. time zone, summer/winter time) are uploaded to the user keys and programming key
- USB port



Wall-mounted programmer
Used locally and decentrally (e.g. at entries)

Wall-mounted programmer

- Programming of temporary access of user keys (e.g. valid for 24 h)
- Programming tasks run automatically with optical and acoustic signals
- Battery alert service
- Power supply via 12 – 24 V mains connection or “Power over Ethernet”

- Outdoor version for areas required to be vandal proof (protection rating IP65 and IK09 - vandal proof)
- Mini USB connection for data exchange over cable
- Waterproof (protection from drips)



Mobile programmer
Location independent and used directly at the key carrier

Mobile programmer

- Permits changes to times and authorisations for user keys as well as the read-out of audit trails
- Receives programming changes to the user key via mobile or PC
- Acoustic and optical signals for operating status and activity progress
- Data transfer to the mobile via Bluetooth and to the PC via USB, no software installation on the mobile programmer

- Battery alert service
- Power supply from standard batteries (4 x type AAA)
- Mini USB connection for data exchange over cable
- Waterproof (protection from drips)

ASSA ABLOY is the global leader in door opening solutions, dedicated to satisfying end-user needs for security, safety and convenience

www.assaabloy.com

ASSA ABLOY

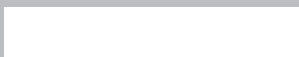

Abloy secures people, property and business operations on land, at sea, and in the air - in all circumstances

ASSA ABLOY is the global leader in door opening solutions, dedicated to satisfying end-user needs for security and convenience

Abloy UK
School Street
Willenhall
West Midlands
WV13 3PW
+44 (0)1902 364500
www.abloy.co.uk
marketing@abloy.co.uk



An ASSA ABLOY Group Brand **ASSA ABLOY**